



FORCED AIR DRYER

(Original Instructions)



IMPORTANT INSTRUCTIONS

SAVE THESE INSTRUCTIONS FOR FUTURE REFERENCE

This manual covers assembly, operation, maintenance and troubleshooting.

800-654-4205 – 1100 Jefferson Street – Pacific, MO 63069 USA

www.bbcind.com

WARNINGS

The operator should familiarize themselves with this manual and all the **WARNINGS** before installing or working on this heater to avoid potentially hazardous conditions, severe property damage, personal injury, or death.

1. BBC Industries is interested in the safe operation of its equipment. All wiring to this equipment must be connected to the source in strict accordance with all local codes having jurisdiction.
2. A dedicated electrical (earth) ground is required for proper operation of the equipment.
3. This equipment is meant for the drying/curing of non-flammable Plastisol and water-based screen-printing inks and dies on textiles or the like. Use for any other purpose may cause fire, electric shock, or injury to persons.
4. This heater is for indoor, non-residential use.
5. Install unit in a location with adequate emergency exits.
6. Place unit in an area with adequate spacing and lighting for installation, operation, and maintenance.
7. The dryer has hot and arcing or sparking parts inside. Do not use it in areas where gasoline, paint, or flammable vapors or liquids are used or stored.
8. Use the dryer in a well-ventilated space. Refer to the Safety Data Sheet (SDS) for any inks or dies that you are curing.
9. The area around this equipment should be designated as a work zone with only trained and authorized personnel allowed in the work zone.
10. Keep the work zone clean and free of debris. A perimeter of at least 18 inches (.5 m) around the equipment is recommended.
11. Do Not use extension cords to power this equipment.
12. Recommended temperature range of 41°F (5°C) to 104°F (40°C) for operation with humidity levels between 40 – 70% to avoid static buildup and discharge.
13. This equipment is hot when in use. To avoid burns, do not touch hot surfaces. Do not set objects on the unit.
14. Check to see that no objects are on the conveyor and the dryer is free from obstructions before operating the dryer.
15. Puncture of the heating element face may result in a shock hazard. Do not operate if heater face is damaged.
16. Do not operate the heater after it malfunctions. Disconnect power at service panel and have the dryer inspected by a qualified technician before reusing.
17. To disconnect the dryer, turn off power to heater circuit at main disconnect panel.
18. Do not insert or allow foreign objects to enter any ventilation opening as this may cause an electric shock or fire, or damage to the dryer.
19. Do not leave the unit unintended while in use.
20. Do not wear loose or dangling clothing while operating this equipment.
21. If a blockage occurs along the conveyor, immediately turn off power to dryer and allow it to cool before removing blockage.
22. This conveyor dryer ships on a skid weighing upwards of 550 lbs. Be aware of the weight when handling.
23. Before storing this unit, allow the heater to fully cool and disconnect from the power source. Be aware of the weight of the unit and take precautions while handling these weights.
24. This dryer is designed to withstand all pressures and forces during shipment, assembly, dismantling, and all other reasonably foreseeable actions, so as long as instructions in this manual are followed.
25. This unit does not require lengthy concentration that would lead to discomfort, fatigue, or physical and psychological stress.
26. These units do not produce noise exceeding 70 dB(A).
27. Use this dryer only as described in this manual. Any other use not recommended by the manufacturer may cause fire, electric shock, or injury to persons.
28. Handle unit in a safe manner.

Assembly Instructions

Unpack, inspect and identify all the shipped equipment and parts. Immediately report any suspected lost or damaged items to Customer Service 800-654-4205

Your Forced Air Dryer crate will include the Dryer Chamber with Legs, Tensioning Conveyor Assembly, Conveyor Drive Assembly, Conveyor Belt and Hardware Kit (**See Fig. 1**).

Confirm that all are present. Contact BBC Industries immediately if there is a discrepancy.

Tools Required for Assembly: 1/2-inch wrench or socket, Phillips and flathead screwdrivers, 1/4-inch hex (or Allen) key, and a needle nose pliers.

WARNING – DO NOT plug the equipment in (or apply power) until instructed to do so.

WARNING – Assure that all appropriate “**LOCK-OUT / TAG-OUT**” procedures are followed to prevent power distribution to the control panel before called for in these instructions.

Electrical Specifications:

SINGLE PHASE DRYERS:

Voltage: 240/208 Volts 50/60 Hz

Single Phase Voltage	Model Number FA-244-X-X	Model Number FA-364-X-X
240V	7.3 kW / 32 A	11.0 kW / 47 A
208V	5.5 kW / 28 A	8.5 kW / 41 A

3-PHASE DRYERS:

Voltage: 240/208 Volts 50/60 Hz

Three Phase Voltage	Model Number FA3-244-X-X	Model Number FA3-364-X-X
240V	7.3 kW / 21 A	11.0 kW / 34 A
208V	5.5 kW / 18 A	8.5 kW / 29A

ASSEMBLY INSTRUCTIONS

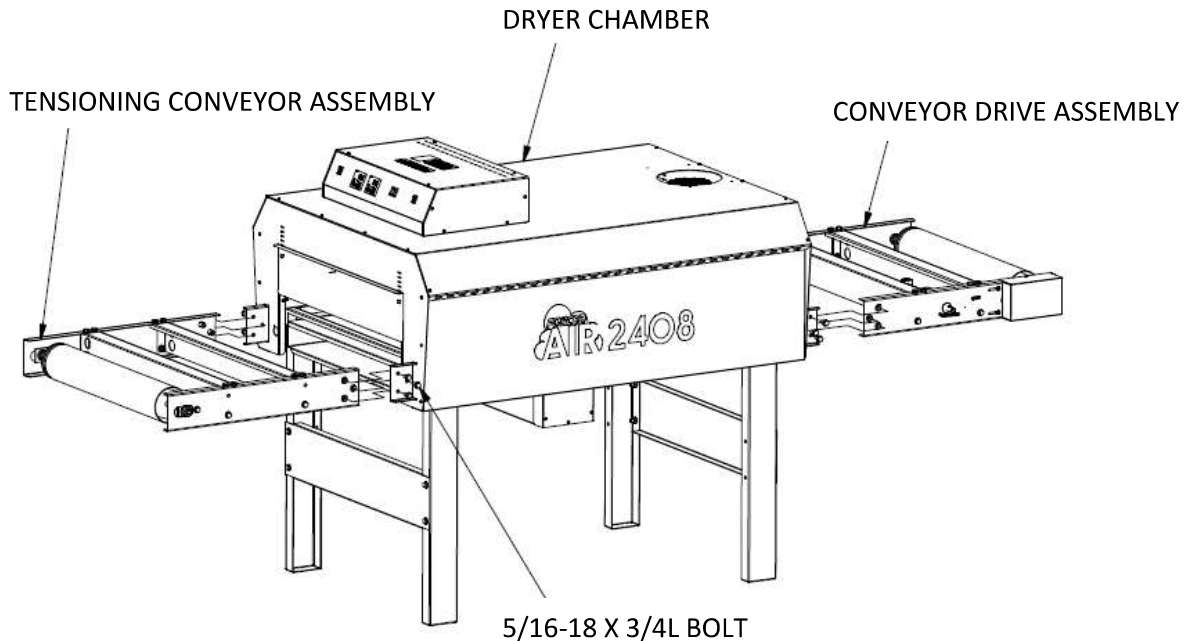

Fig. 1 – Dryer Assembly

1. Remove DRYER CHAMBER from crate.
2. CONVEYOR DRIVE ASSEMBLY:
 - a. Locate the Assembly. It consists of a 4-inch roller and drive motor among other parts.
 - b. Fit the Conveyor Rails inside the rails protruding from the DRYER CHAMBER and using (6X) of the provided 5/16-18 x 3/4L BOLTS, attach the assembly.
 - c. Route the plug connector through the holes in the Cross-Members.
 - d. Connect the plug to the socket on the heater frame. Push the connector until fully seated and twist to lock.
3. TENSIONING CONVEYOR ASSEMBLY:
 - a. Locate the Assembly. It consists of a 4-inch roller mounted through sliding bearing assemblies among other parts.
 - b. Fit the Conveyor Rails inside the rails protruding from the DRYER CHAMBER and using (6X) of the provided 5/16-18 X 3/4: BOLTS, attach the assembly.

4. CONVEYOR BELT:

- a. You will need an assistant for this step in the assembly.
- b. Loosen (but do not remove) the bolts holding the sliding bearing assemblies on the TAKE-UP ASSEMBLY.
- c. Locate the end of the CONVEYOR BELT that contains the splice pin.
- d. Remove the pin, but **DO NOT** bend or discard this pin. We will reinsert it later.
- e. The *TrueTrak™* rubber Edge Guide on the CONVEYOR BELT is designed to between the guide plates on the Drum Roller.
- f. *Feed* the CONVEYOR BELT through the DRYER CHAMBER then around an end roller and back through the lower chamber.
- g. Bring the ends of the CONVEYOR BELT together. Use a straightedge on the Edge Guide side of the belt to assure alignment when you mesh the teeth of the splice. If you are off one tooth, the BELT may jump from the guide plates.
- h. While your assistant holds the ends of the CONVEYOR BELT together, properly meshing the teeth, reinsert the splice pin. The needle-nose pliers will be needed for the last inch or so.
- i. Move to the TENSIONING CONVEYOR ASSEMBLY end of your Dryer.
- j. Pull on the Roller Drum by hand to remove some slack from the belt and tighten the bolt on the bearing assemblies. Do not over-tension, too much tension and the splice can be damaged over time.

CONNECTING UNIT TO POWER

This unit is not supplied with a power cord. Have a **certified electrician** connect the unit to power in accordance with local electrical codes.

⚠ DANGER

Before servicing or cleaning, switch power **OFF** at service panel and lock service panel to prevent dryer from being switched on accidentally. If the service panel cannot be locked, securely fasten a prominent warning device, such as a tag, to the service panel.

1. Using a Phillips screwdriver, remove CONTROL PANEL COVER.

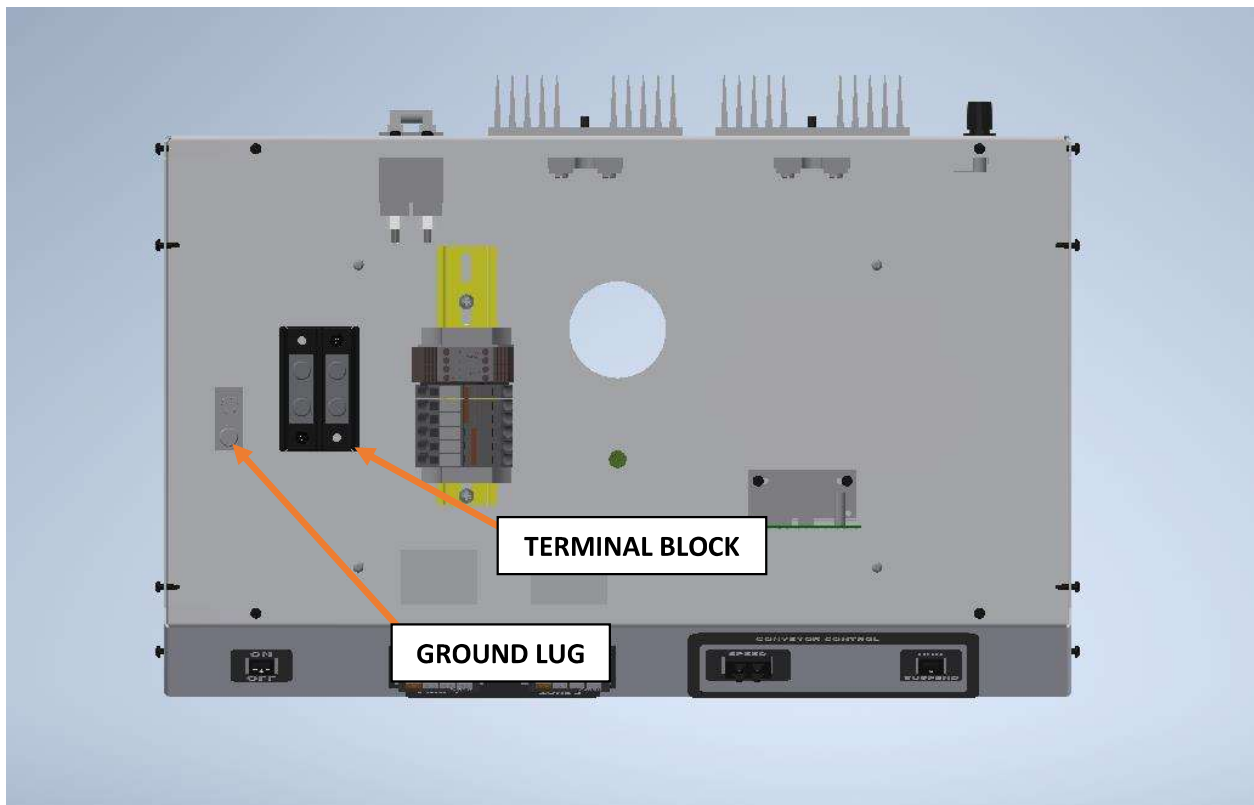

FIG. 2 – SINGLE PHASE Control Panel

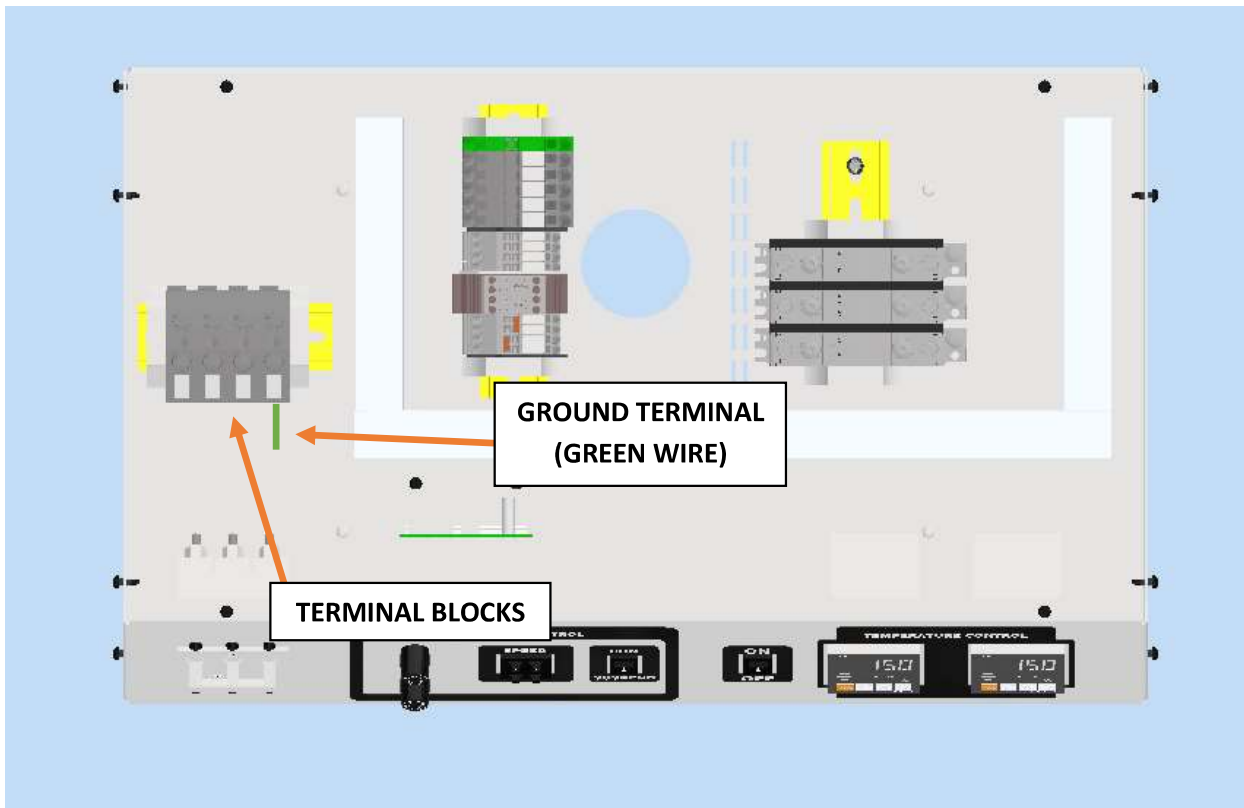

FIG. 3 – 3-PHASE Control Panel

2. Connect power supply to appropriate terminal blocks.
3. Insert and tighten grounding lead wire into GROUNDING LUG or GROUNDING TERMINAL across from green wire.
4. Place the HOT (and Neutral for 415Y/240V 4-Wire power) leads into the open side of the large TERMINAL BLOCK and tighten set screws (FIG. 2 & 3). BE SURE NOT TO CLOSE WIRE INSULATION IN TERMINAL BLOCK.
5. Once all connections have been made, tug on the leads to make sure they are fully secured.
6. Replace the CONTROL PANEL COVER careful not to pinch any leads.

IMPORTANT: After one week of operation, disconnect the unit from power, remove cover and re-tighten set screws. REPEAT in one-month intervals until screws no longer remain loose. Periodically check to assure the set screws are remaining tight.







DO NOT OPERATE DRYER WITHOUT COVERS IN PLACE

OPERATING INSTRUCTIONS

The **FORCED AIR DRYER (Combination Forced Air / Infrared Dryer)** is designed to cure both Plastisol & Water-Based screen print inks as well as Digital Ink-Jet printer inks with utmost efficiency. Two different temperature dials are available to allow for maximum production. By setting **Zone 1** higher than **Zone 2** your dryer will have a profile that *Plateaus* allowing faster cure times by obtaining higher shirt temps early in the process and holding those temperatures without surpassing scorching temperatures. The **Forced Air** is essential for all water-based inks, whether screen-printed or digitally printed. The blower constantly introduces fresh, Hot, and dry air into the curing chamber. It does not recycle saturated humid air within the chamber like other dryers. The **Forced Air** cannot be turned **OFF** as it is also used to insulate the dryer and keep the outside skin cool.

1. Switch the Main Power Breaker to the **ON** position.
2. Flip the switches for Temperature Control and Conveyor Control to the **ON** position.
3. The display on the temperature controller shows the current element temperature.

Note: This is not the air temperature inside the dryer, rather the temperature of the heating element itself.

Press the , , and  keys to show and change the Set-Point Temperature then  to enter.

4. The conveyor display on the speed controller is from 00 to 99. The correct speed will need to be tested and adjusted for.

Press the + & - keys to adjust each digit.

5. Once the temperature has reached the Set-Point, allow an additional 5 – 10 minutes for the dryer to reach equilibrium.
6. **If the temperature setting is changed, allow 5 minutes for dryer to reach equilibrium. (Longer is fine too)**

Listed below are suggested initial settings for your **FORCED AIR DRYER**. There are many factors that influence the curing of different inks. **Test prints need to be produced and wash-tested to determine the best possible settings for your application.**

Table 1 – Suggested Settings for Initial Startup.

Ink Type	Zone 1	Zone 2	Conveyor Speed
Plastisol	900°F	700°F	00:30
Screen Printed Water-Based	800°F	600°F	1:00
Digital Ink-Jet	750°F	550°F	2:00

Your dryer setting will likely be different than those listed above. This Table is a suggested starting point. If your shirts are scorching, it is too hot. If they are not fully cured, the dryer temperature is too low. Allow the dryer to ‘soak’ at the new setting for a few minutes before running product through it at the new setting.

(TIP- Change only 1 setting at a time. Changing multiple settings can result in confusion and longer discovery of proper cure settings.)

Washing the garments is your definitive test on the effectiveness of the dryer settings. Test and retest until you have found a setting for your dryer, your shirts, and your inks. Your customers will appreciate it!

TROUBLESHOOTING

If dryer does not hold temperature at set-point (within 5° – 10°F):

1. Confirm the dryer is getting proper voltage. A drop in voltage will decrease the temperatures in the dryer.
2. Reduce any drafts or air currents such as open doors, fans, air conditioners that could be blowing into the chamber. Do not direct fans at the dryer, this will cause temperature variations in the chamber.
3. If temperature controller displays “OPEN” then the thermocouple has failed or become disconnected. Replace if necessary.
4. If temperature does not rise at all or passes through set-point and continues to heat, Solid State Relay (SSR) may have failed. It can fail in the open or closed position. Replace if necessary.

If the Conveyor Belt or Forced Air blower stops, check to see if fuse on backside of Control Panel has tripped. Push to reset.

CONTROL PANEL MAINTENANCE

Performed at initial installation, 30 days after initial installation, and 120 days after initial installation.

1. Turn **OFF** the power serving the main control panel where it is connected to the building electrical distribution system.

Note: Assure that appropriate “**Lock-Out / Tag-Out**” procedures are followed before conducting any of these activities.

2. Remove the control panel cover. Using a voltage meter, confirm that no dangerous voltages are present. If you do not have a meter or are not confident with any of these procedures, contact a qualified electrician.
3. Check for any wire/component damage or discoloration. Contact *BBC Industries* Technical Support with any concerns.
4. Tighten all electrical screw terminations inside the panel.

Please contact the service department at *BBC Industries* (800-654-4205) or service@bbcind.com with any questions regarding these instructions.

